



PlayMaker Hoops Installation Instructions Model 306A

306A



WARNING!

Before beginning any excavation, call your local **Underground Service Locator** company to make sure there are NO electrical power, natural gas, telephone, cable television, irrigation systems or other services in the area you plan to install your new goal system. Cutting into underground electrical and/or natural gas service(s) can result in serious injury or death. Cutting into these or other services may also result in installation delays, loss of service, repair fees, or fines and/or penalties in some locations. **CHECK FIRST, THEN DIG.**



IMPORTANT!

Please review all instructions prior to assembly. It is important that you fully understand the entire installation process before you start. If you doubt your ability to safely install this system, you should call an experienced installation professional to complete the project.



IMPORTANT!

Never over-crank the jack while raising or lowering goal. Attempting to continue to crank the jack after the lower arms contact the safety stop will irreparably damage the jack and void the warranty.

OVERVIEW:

The installation process consists of two separate phases:

1. Setting the anchor system (allow 48 hours for concrete cure)
2. Setting the pole, adding backboard/rim assembly, final leveling check

The first phase can be done by one person.

The second phase is a three person project (yourself and two others).

Each phase can be completed in less than an afternoon.

Total time: parts of three days, weather permitting.

TOOLS AND MATERIALS REQUIRED:

For The Anchor

- Shovel(s) digging/mixing
- Wheel barrow
- Post hole digger
- Ten to twelve 80# bags of 5,000 psi concrete mix
- 10# bag of non-shrink grout
- Water for mix and clean-up
- Old toothbrush to clean threads

For The Pole/Backboard

- 9/16", 3/4", 1-1/8" wrenches
- 9/16", 3/4" socket & driver
- 24" spirit level
- Wide putty knife
- Large Phillips screwdriver
- Small needle-nose pliers
- Utility knife to trim Bbd. cover film
- Grease gun
- Three sturdy 8' step ladders
- Portable drill with socket adapter (adjustable torque)
- Masking tape
- Tape measure



PlayMaker Hoops Installation Instructions Model 306A

306A

THE BOLT KIT:

It's packed so all parts for every phase of installation are in this kit.

First select the bolts, nuts and washers needed for the anchor assembly. This is the anchor template, two bent anchor bolts, four 3/4" leveling nuts, eight 3/4" flat washers, eight 3/4" top locking nuts and four anchor boots.

THEN: To speed installation phase, put the remaining parts in these groups during the concrete cure (at least 48 hours):

Lower Arms to Pole

- (1) 1/2-13 x 12" Bolt
- (2) 1/2" Flat Washers (FW)
- (4) 1/2" Nylon Washers (NW)
- (1) 1/2" Lock Nut

Jack to Pole

- (3) 3/8-16 x 3/4" stainless steel hex head bolts, nuts, and washers

Jack to Jack Arms

- (1) 1/2-13 x 9" Bolt
- (2) 1/2" Flat Washers (FW)
- (4) 1/2" Nylon Washers (NW)
- (1) 1/2" Lock Nut

Rim to Backboard

- (4) 3/8-16 x 3-1/2" Bolts
- (8) 3/8" Flat Washers (FW)
- (4) 3/8" Lock Nuts
- (1) Rim Gasket

Miscellaneous

- (1) 1/2 oz. bottle touch-up paint
- (1) Arrow decal

Jack Arm to Lower Arms

- (1) 1/2-13 x 12" Bolt
- (2) 1/2" Flat Washers (FW)
- (4) 1/2" Nylon Washers (NW)
- (1) 1/2" Lock Nut

Upper Arms to Pole

- (1) 1/2-13 x 8" Bolt
- (2) 1/2" Flat Washers (FW)
- (4) 1/2" Nylon Washers (NW)
- (1) 1/2" Lock Nut

Backboard to Arms

- (4) 1/2-13 x 1-1/2" Bolts
- (8) 1/2" Flat Washers (FW)
- (10) 1/2" Nylon Washers (NW)
- (4) 1/2" Lock Nuts
- (2) Special 2" OD Nylon Washers - Lower Arms to Backboard Tabs

Available Backboard Pads

- (2) Molded Backboard Pads
- (1) Extension Pad for 72" Bkbrd.
- (8) Self-tapping Screws
- (8) Screw Protectors



PlayMaker Hoops Installation Instructions Model 306A

306A

THE HARDWARE:

It's packed in multiple boxes: includes two upper arms, one pair lower arms, two jack arms, pole assembly, jack, anchor kit, backboard assembly, backboard pad set, rim kit and gasket.

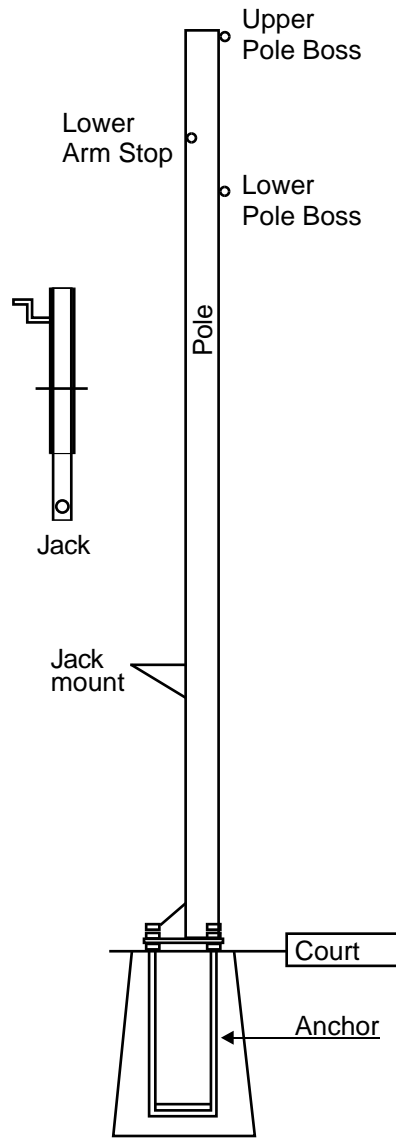

(Side View)

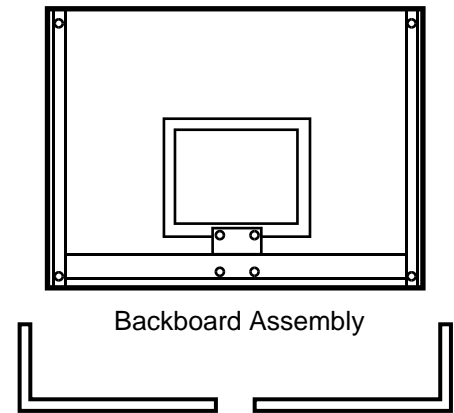
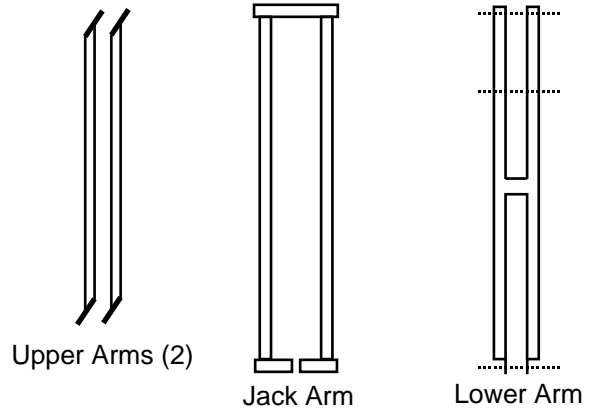

Available Backboard Pad Set w/ mounting hdwe.

Rim Assy. w/ mounting hdwe.

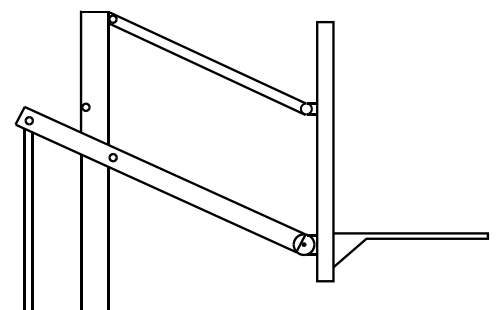
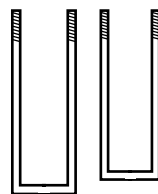
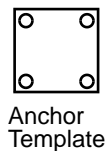
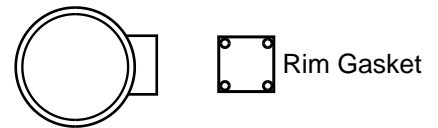



PlayMaker Hoops Installation Instructions Model 306A

306A

PHASE ONE - INSTALL THE ANCHOR:

The base is the strongest part of the PlayMaker Basketball Goal System. It's also the only permanent part of the installation process. If you move, you can take your PlayMaker goal with you. Just get a new anchor assembly for your new location.

Be sure you have checked for any underground services (electrical, natural gas, telephone, television cable, irrigation system, etc.) before you dig.

1. Assemble anchor bolts with nuts, washers, and the template as shown.
2. Dig the hole a minimum of 20" x 20" square and 36" deep about 1 foot on-center from the play surface. A slight "bell" shaped hole that is wider at the bottom will wedge the concrete tighter in the hole. If the grade slopes away from the play area, you will need to make concrete forms. Forms hold concrete in place while it cures, helping you to merge the play surface to the anchor concrete for a neater appearance.
3. Mix concrete according to instructions on the bag. Mix enough to fill the hole about 10" from the top. Install the assembled anchor system into the wet concrete and align two of the four bolts parallel to the court/play area. Anchor depth is critical. The bottom of the threads on the anchor should be about 1" below the level of the play area.
4. After checking that the anchor is square with the play area and at the proper depth, finish filling the hole with concrete to the bottom of the anchor threads. DO NOT cover the lower "leveling" nuts with concrete. These nuts need to turn to plumb the pole. Now is a good time to adjust the nuts so they occupy about the same horizontal plane.
5. Clean the threads of the anchor with an old toothbrush to be sure there is no concrete in the grooves. Don't forget proper cleanup of your concrete mixing area/equipment.



ALLOW 48 HOURS FOR CONCRETE TO CURE

Top View:

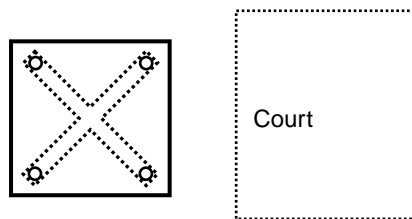

Side View:

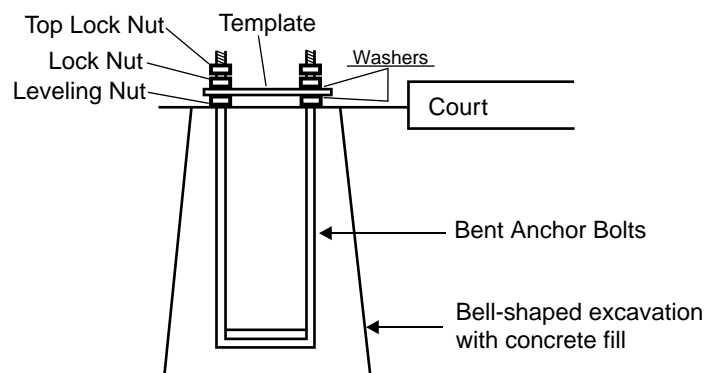



PlayMaker Hoops Installation Instructions Model 306A

306A

PHASE TWO - INSTALL THE POLE AND BACKBOARD:

This phase has 18 steps, described and illustrated over the following pages.

- 1.** Remove the top locking nuts, top washers and anchor template from the four anchor posts. The lower nuts and washers remain on the anchor posts; they provide a leveling function by adjusting the pole's baseplate. You might add a drop or two of common household oil on each anchor post, and turn the nuts a few times each way to be sure concrete has not fouled the threads. Now is a good time to make sure all the nuts are level, in the same plane, before adding the pole.
- 2.** You will need help in setting the pole upright on the anchor. First, align the two front holes in the pole baseplate with the two front anchors, then stand the pole upright, bringing the back baseplate holes onto the back anchors. Let the pole stand on the lower flat washers and leveling nuts. Make sure the upper and lower pole bosses (on the top of the pole) face the court/play area and the adjustment jack (on the back of the pole) faces away from the court/play area. Before you release the pole, replace the top washers and nuts. Replace the top locking nuts to secure the pole so it will stand on its own, but leave them loose enough to make adjustments to the lower leveling nuts, next.
- 3.** Now make an initial adjustment to the anchor's lower leveling nuts under the pole baseplate to move the pole to a vertical (plumb) position. Use a spirit level. Check for plumb in both front/back and left/right planes as you face the pole. Getting it accurate now means less finishing adjustments will be needed later after adding the backboard assembly. Tighten the top nuts on the anchor to firmly secure the pole.



NOTE: Nylon washers are to be installed next to all painted, moving surfaces to function as a low friction bushing. A small amount of grease applied to each side of the nylon washers when installed makes the goal raise/lower more smoothly.

- 4. Lower Arms to Pole.** Put a flat washer (FW) and a nylon washer (NW) on a 1/2 - 13 x 12" bolt. Have a helper hold the lower arm pair in position to line up the lower arm "middle" holes with the lower pole boss. Insert the bolt/washers through the "middle" hole on one of side of the lower arm pair. Add a nylon washer between the inside of lower arm and the pole boss. Repeat for the other side. Continue to insert the bolt through the other side of the lower arm's "middle" hole. Place a nylon washer (NW), a flat washer (FW) and a nut on the bolt. Finger tighten this, and you will come back and tighten all nuts when the system is assembled further. The lower arms are now attached to the pole as shown in the illustration below.

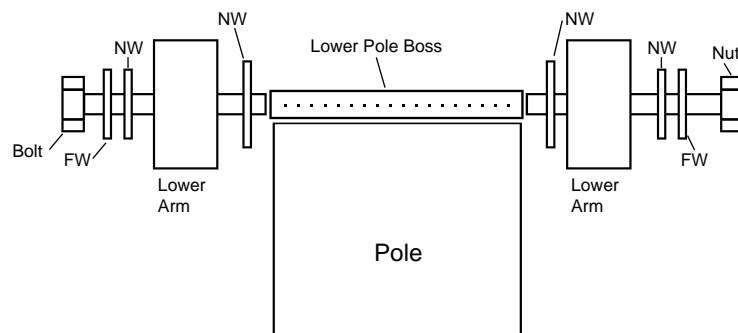



PlayMaker Hoops Installation Instructions Model 306A

306A

PHASE TWO - INSTALL THE POLE AND BACKBOARD (continued):



IMPORTANT!

Never over-crank the jack while raising or lowering goal. Attempting to continue to crank the jack after the lower arms contact the safety stop will irreparably damage the jack and void the warranty.

7. Jack to Jack Arms. Attach the lower end of the Jack Arms to the Jack. Put a flat washer (FW) and a nylon washer (NW) on a 1/2 - 9" bolt. Insert the bolt through one Jack Arm. Add a nylon washer (NW) and continue to insert the bolt through the hole on the Jack Inner Barrel. Add another nylon washer (NW) and slide the bolt through the second Jack Arm. Add a nylon washer (NW), a flat washer (FW) and lightly tighten the locking nut. Jack Arms should now be connected to the Jack as shown in the illustration below.

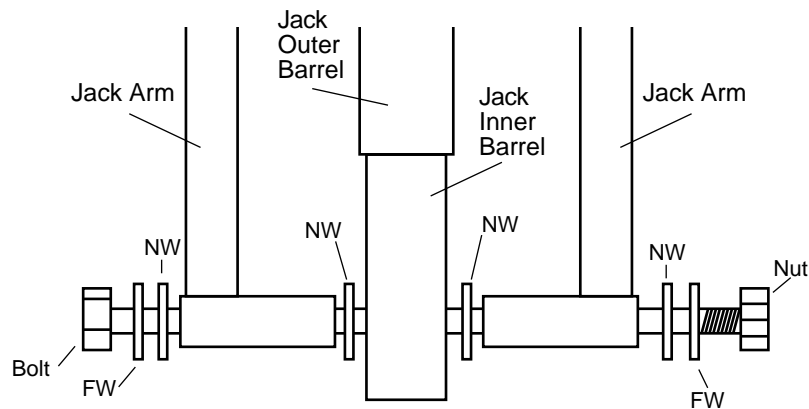

8. Upper Arms to Pole. Put a flat washer (FW) and a nylon washer (NW) on a 1/2 - 13 x 8" bolt. Insert this assembly through the end of the first upper arm. Add a nylon washer (NW) and insert this (bolt, washers and upper arm) assembly into the upper pole boss. Now add another nylon washer to the bolt. Place the second upper arm hole on the bolt. Place a nylon washer (NW), a flat washer (FW) and a nut on the bolt. Moderately tighten the nut. The upper arms are now attached to the top of the pole as shown in the illustration below.

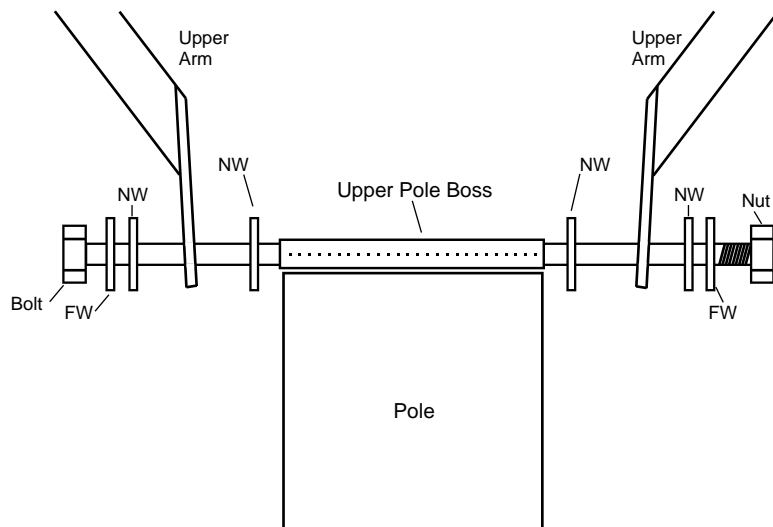



PlayMaker Hoops Installation Instructions Model 306A

306A

PHASE TWO - INSTALL THE POLE AND BACKBOARD (continued):

9. Rim to Backboard. Now attach the rim to the backboard. Put a 3/8" flat washer (FW) on each of the four 3/8 - 16 x 3-1/2" bolts. Insert these through the back of the steel backboard frame assembly. On the front of the backboard place the rim gasket over the four protruding bolts, then place the rim itself over the four bolts. Add a 3/8" flat washer (FW) on each of the four bolts and moderately tighten the nuts. Wait to tighten the rim. One of the last steps is to level the rim after final assembly.

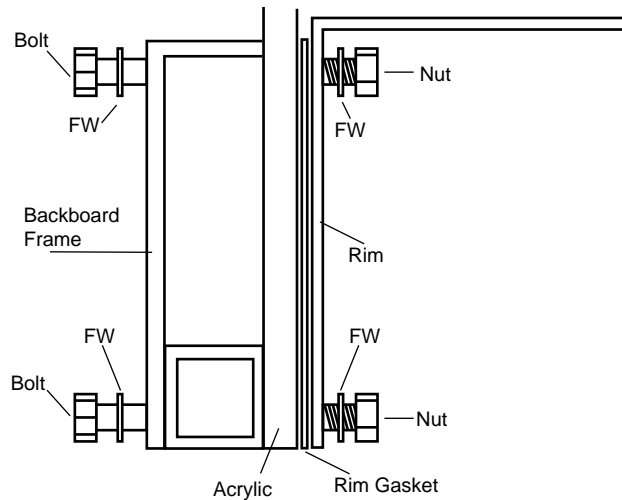

IMPORTANT!

Never over-crank the jack while raising or lowering goal. Attempting to continue to crank the jack after the lower arms contact the safety stop will irreparably damage the jack and void the warranty.

10. Backboard to Lower Arms. It is important to plan your lift ahead of time. Here's where you will need two sturdy 8' step ladders and the help of two friends. First, compress the jack so the front of the lower arms are at their lowest point. Put a flat washer (FW) and a nylon washer (NW) on each of two 1/2-13 x 1-1/2" bolts. Get your helpers to lift the backboard assembly to a height that matches the holes in the front of the lower arms. The lower arm tabs fit to the outside of the lower backboard tabs. Use proper lifting technique, the backboard assembly is quite heavy. Starting outside the lower arm tabs, insert the bolt through the lower arm tab, through the special 2" diameter nylon washer, then through the lower backboard tab. Next, add a nylon washer (NW), a flat washer (FW) and lightly tighten the locking nut. Repeat for the other side.

11. Backboard to Upper Arms. Rotate the upper arms so they match up with the inside of the upper tabs on the backboard frame. Put a flat washer (FW) and a nylon washer (NW) on each of two 1-1/2" bolts. Put a bolt through the backboard tab, add a nylon washer (NW), and put the bolt through the upper arm tab. Add a nylon washer (NW) and a flat washer (FW), and loosely tighten the locking nut. Repeat for the other side. You're almost done!

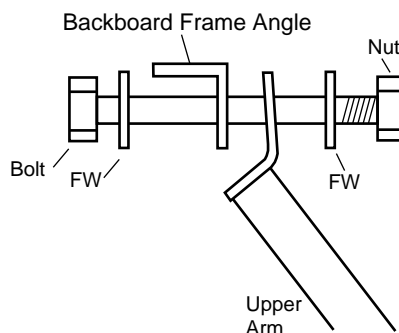



PlayMaker Hoops Installation Instructions Model 306A

306A

PHASE TWO - INSTALL THE POLE AND BACKBOARD (continued):

12. Now it is time to fine tune the system. The objective is to make the face of the backboard vertical (plumb) and the rim horizontal (level). The backboard is adjusted by raising/lowering the corners of the pole's baseplate using the lower nuts on the anchor underneath the baseplate. To do this, loosen the locking nuts above the baseplate and turn the lower leveling nuts under the baseplate to lean the pole left, right, forward or backward. When the backboard is plumb, lock down the top anchor nuts with the third anchor nuts. Next, level the rim and tighten its mounting hardware. Tighten all pivoting bolts to stiffen the goal and eliminate rattles.

13. IMPORTANT: do a final plumb and level check. The space between the bottom of the baseplate and the top of the concrete should now be filled using a non-shrink grout. Mix the grout to a stiff consistency and pack it into the space under the baseplate. This will protect the anchor system from the elements and permanently lock the pole into position.

14. The next step is to install the backboard pads. This greatly increases player safety and is highly recommended. Each PlayMaker hoop has available custom designed molded urethane backboard edge guards to exactly fit your particular model.

Use a tape measure to mark the centerline on the backboard. Place backboard pads on the centerline of the board and use masking tape to hold them in position. (If using optional Extension Pad for larger backboards, center it on board and tape into place, then work your way outward with the padding.) Install the other half of the padding and tape in place.

15. Check the fit of the edge guards and reposition if needed. It may be necessary to trim away some material to fit around goal or supports. **NOTE: CHECK FASTENER LOCATIONS TO MAKE SURE THEY WILL NOT DAMAGE THE BACKBOARD GLASS.**

16. Using a portable drill with torque adjustment at lowest setting, fasten the edge guards in place with the provided self-drilling, self-tapping screws. **NOTE: DO NOT OVERTIGHTEN SCREWS, IT MAY STRIP OUT THE SCREWS.**

17. If the sharp tips of the mounting screws are exposed after installation, place the protective screw caps over the tips to prevent injury. Collect any metal shavings that may have fallen into the play area. Remove masking tape.

18. Raise goal to a measured height of 10' from rim to court. Add the Arrow decal to a jack arm pointing at the 10' mark on the factory-mounted Height Indicator decal. Enjoy your new PlayMaker Hoop!

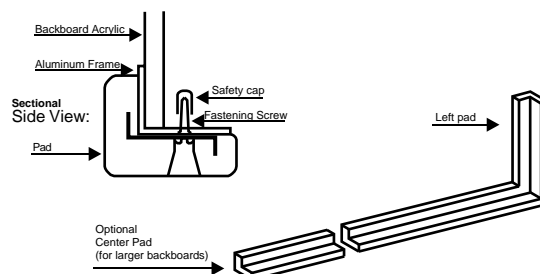



**PlayMaker Hoops
Installation Instructions
Model 306A**

306A

Maintaining Your Goal

Periodically clean your backboard with mild soapy water and a squeegee to keep the acrylic surface looking new. **DO NOT USE "WINDEX" OR OTHER AMMONIA BASED CLEANERS.** Use the supplied touch-up paint to cover any nicks to the paint on metal surfaces to help prevent rust. Annually grease the gears inside the jack body.